

FILE: J:\CUSTDWG\DC\CA009202

INDUCTANCE	LOSSES	WEIGHT
0.6 mH	34 Watts	23 Lbs

NO.	CHANGE DESCRIPTION	BY	DATE	C'K'D
-----	--------------------	----	------	-------

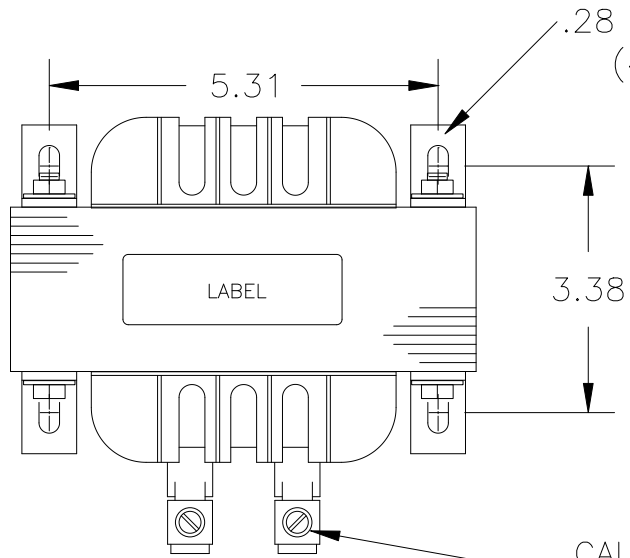

WIRE RANGE: 6-0 AWG

CAUTION-TERMINAL SCREW TIGHTENING
 TORQUE: 6-4 (45) in-lb MAX.
 2-0 (50) in-lb MAX.

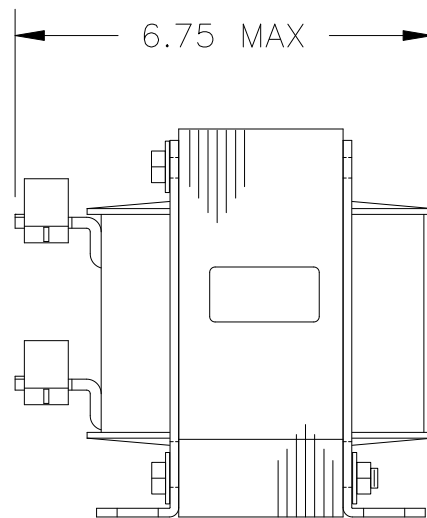
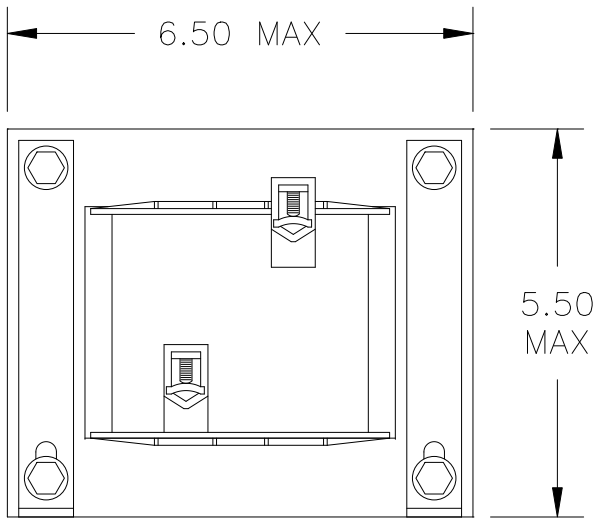

UNLESS OTHERWISE SPECIFIED, DIMENSIONS ARE IN INCHES [mm] AND TOLERANCES ARE:

DECI. FRAC.
 ANGLES DRILLED HOLES

PART NAME:	DC CHOKE
DESCRIPTION:	OUTLINE DIMENSION
FINISH:	

MTE CORPORATION MENOMONEE FALLS, WISCONSIN			
DCA009202			REV. 00
SCALE	NTS	DATE 06/28/05	C'K'D
REF.	DR. BY AGK	APP'D	